

## Moodspot TW2000 Bracket

### Technical specifications



<b>LED</b>	Colour temperature:	4000K~1400K (Default setting) 5500K~1400K (User setting)
	Colour rendering:	Ra > 90 / R9 > 90 (CCT @ 3000K)
	Colour variation:	3 MacAdam Elipse
	Lumen output:	2000 lumen (3000K)
	Dimming range:	Smooth dimming to 0%
	User-mode:	CCT-tuning and Warm dimming
Efficiency:	>90%	
<b>Power</b>	Power supply:	48VDC IZI-Link
	Current:	750mA
	Consumption:	34 Watt
<b>Miscellaneous</b>	Material:	Aluminum (lens: PMMA)
	Lifespan:	> 40.000 hours L80 [10K]
	Lenses:	13° / 20° / 35° / 45°
	Weight:	860 gram
	IP-Rating:	IP20
	Cable length:	300mm 2-core wire*
	Connection:	WAGO 770-252 / Winsta MIDI / 2-pole
<b>Accessories</b>	Accessories:	Snout / Honeycomb / Barndoors
	Connectors:	WAGO male & female / T-block
<b>Version</b>	Flange:	Black or white finish
<b>Control</b>	Driver:	Built-in IZI-link driver
	Control:	IZI-link system

\*Other lengths are available on request

### Dimensions

Overall dimensions: 130/100 x 222mm

Housing: Adjustable 360°

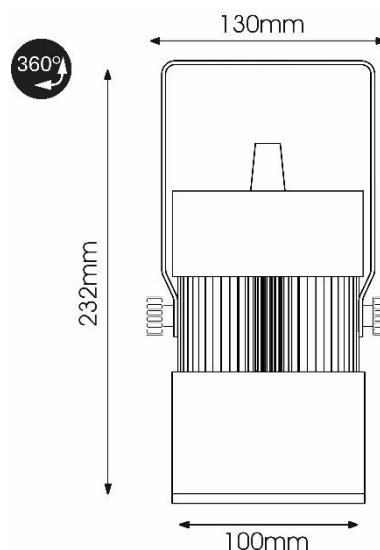

The Moodspot TW2000 Bracket is a **Tunable White LED spot** which alters the emotional experience of a certain space. With its **internal IZI-link LED driver** it can perfectly mimic **halogen style dimming**, the Moodspot embraces the black body curve while **dimming flicker free** all the way down to 0%.

#### Features:

Smooth and flicker free dimming to 0%

High output of 2000 lumen

Tunable white (Default 4000K~1400K) (User 5500K~1400K)

Lifespan of 40.000+ hours

#### Warranty:

5 years

#### Certifications:



## Photometric data

Polar chart 13° optic

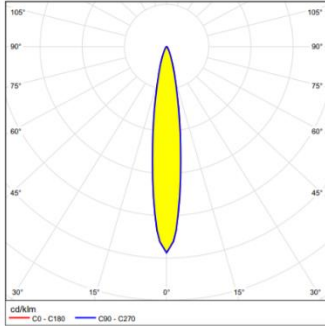

Polar chart 20° optic

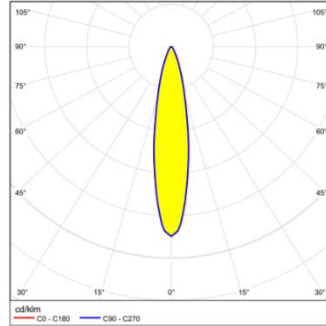

Polar chart 35° optic

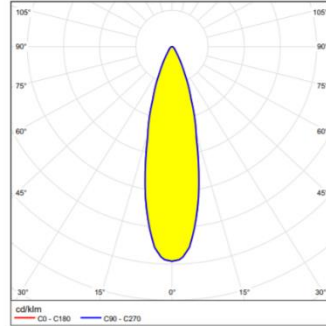

Polar chart 45° optic

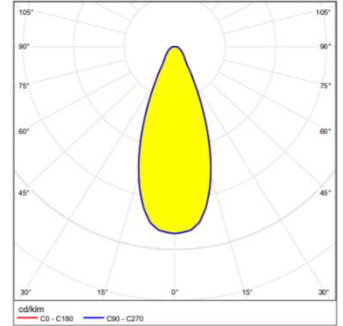

## Black body locus

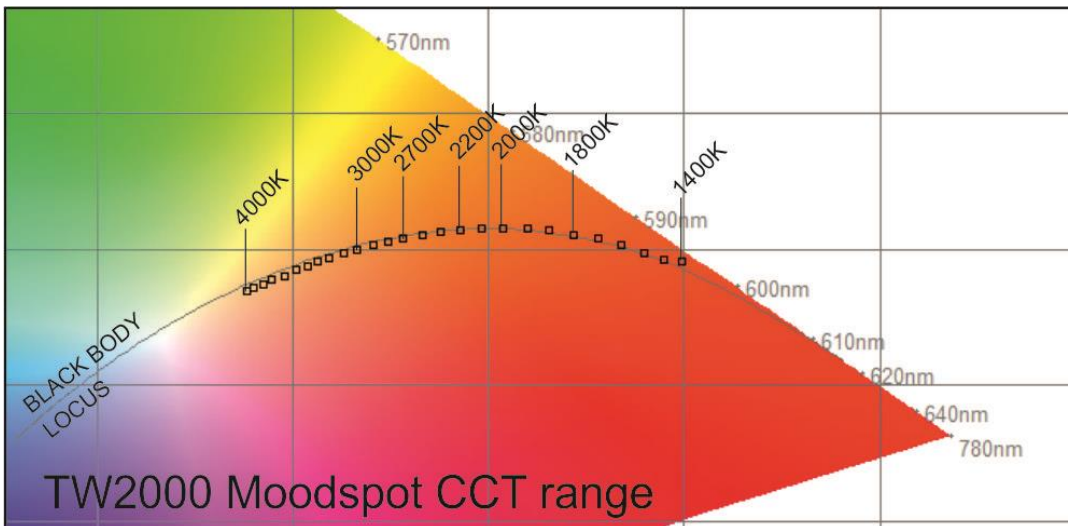

## Order code

### Lenses

Lens 13°  
Lens 20°  
Lens 35°  
Lens 45°

### Black finish

MO.TW2.B.B.13  
MO.TW2.B.B.20  
MO.TW2.B.B.35  
MO.TW2.B.B.45

### White finish

MO.TW2.B.W.13  
MO.TW2.B.W.20  
MO.TW2.B.W.35  
MO.TW2.B.W.45

### Accessories

Snout  
Honeycomb  
Barndoors  
WAGO female  
WAGO male  
T-block + male & female connector  
H-block + male & female connector

HOU.MO.SN.BL  
MO2.HC  
MO2.BD  
MO2.CON1  
MO2.CON5  
MO2.CON2  
MO2.CON4

## Connection IZI-Link

simplified overview of the system. For more detailed information about the IZI-Link system visit our website.

The Moodspot TW2000 Bracket LED spot is prepared with a two wired cable.

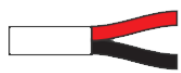

Red: 48VDC IZI-Link (+)

Black: 0V (-)

